

Description

The WI62195 is an enhancement mode GaN-on-silicon half-bridge power circuit of the WiseGan™ power integrated circuits family of Wise-integration. The properties of GaN allow high current, high voltage breakdown and high switching frequency.

Applications

- High efficiency power conversion
- High density power conversion
- AC-DC, DC-DC, DC-AC
- Bridgeless Totem Pole PFC
- ACF (active clamp flyback)
- LLC resonant converter
- Half-bridge topologies
- Synchronous Buck or Boost
- Small-Medium UPS
- Fast Battery Charging

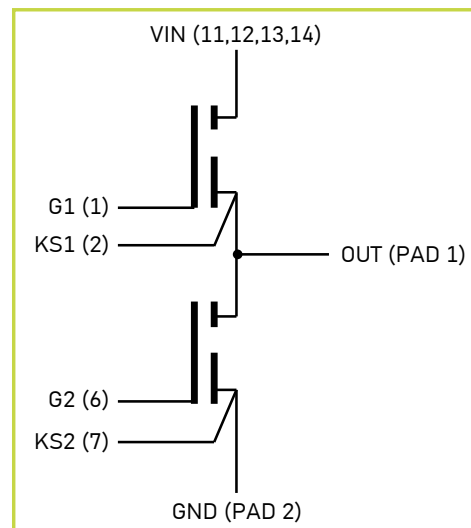

Features

- 650 V enhancement mode half-bridge
- Bottom-side cooled configuration
- $R_{DS(on)} = 195 \text{ m}\Omega$ per switch
- $I_{DS(max)} = 9 \text{ A}$
- Low inductance PDFN package
- Easy gate drive requirements (0 V to 6 V)
- Transient tolerant gate drive up to 7 V
- High switching frequency (>1 MHz)
- Zero reverse recovery loss
- Small 6 x 8 mm PCB footprint

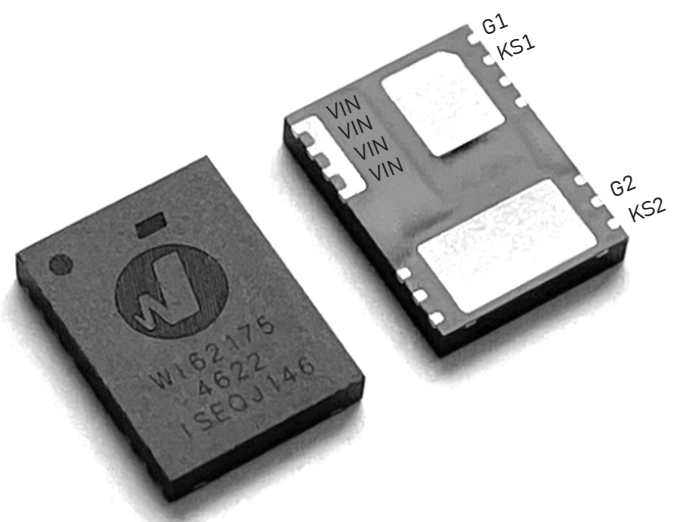

Table of contents

• Features	1
• Applications	1
• Half bridge test circuit	1
• Absolute Maximum Ratings	3
• Operating conditions	3
• Thermal Characteristics	3
• ESD Ratings	3
• Static Electrical Characteristics	4
• Dynamic Electrical Characteristics	4
• Static main characteristics	5
• Package and Packing information	8
• Package Outline Drawing	9
• Tray Dimensions	10
• Ordering Information	11

Absolute Maximum Ratings

Parameter	Symbol	Value	Units
Drain-to-Source Transient Voltage ¹	V _{DS}	750	V
Gate-to-Source Transient Voltage ²	V _{GS}	-2 to +7	V
Operating Junction Temperature	T _J	-40 to +150	°C
Operating Storage Temperature	T _{stg}	-55 to +150	°C

¹ maximum duration is 1ms

² maximum duration is 1μs

Operating conditions

Parameter	Symbol	Value	Units
Continuous Drain-to-Source Voltage	V _{DS (max)}	650	V
Gate-to-Source Voltage	V _{GS}	0 to +6	V
Continuous Drain Current (T _J = 25°C)	I _D	9	A

Thermal Characteristics

Parameter	Symbol	Value	Units
Thermal Resistance (junction-to-case) – bottom side	R _{θJC}	1.9	K/W
Thermal Resistance (junction-to-ambient)	R _{θJA}	35.5	K/W

ESD Ratings

Parameter	Symbol	Value	Units
Human Body Model	HBM	1500	V
Charged Device Model	CDM	1500	V

Static Electrical Characteristics

Characteristics	Symbol	Conditions	Min	Typ	Max	Units
Drain-Source On-Resistance	$R_{DS(ON)}$	$V_{GS} = 6\text{ V}, T_J = 25\text{ }^\circ\text{C}, I_{DS} = 2\text{ A}$		195	250	m Ω
		$V_{GS} = 6\text{ V}, T_J = 150\text{ }^\circ\text{C}, I_{DS} = 2\text{ A}$		380		m Ω
Gate Threshold Voltage	$V_{GS(th)}$	$V_{DS} = V_{GS}, T_J = 25\text{ }^\circ\text{C}, I_{DS} = 10\text{ mA}$	0.9	1.3	1.75	V
		$V_{DS} = V_{GS}, T_J = 150\text{ }^\circ\text{C}, I_{DS} = 10\text{ mA}$		1.8		V
Internal Gate Resistance	R_G	open drain		0.6		Ω
Drain-to-Source Leakage Current	I_{DSS}	$V_{DS} = 650\text{ V}, V_{GS} = 0\text{ V}, T_J = 25\text{ }^\circ\text{C}$		0.2	0.42	μA
		$V_{DS} = 650\text{ V}, V_{GS} = 0\text{ V}, T_J = 150\text{ }^\circ\text{C}$		6		μA
Gate-to-Source Leakage Current	I_{GSS}	$V_{GS} = 6\text{ V}, V_{DS} = 0\text{ V}, T_J = 25\text{ }^\circ\text{C}$		22	50	μA
		$V_{GS} = 6\text{ V}, V_{DS} = 0\text{ V}, T_J = 150\text{ }^\circ\text{C}$		200		μA
Source-to-Drain Reverse Voltage	V_{SD}	$V_{GS} = 0\text{ V}, I_{SD} = 5\text{ A}$		3.25		V
		$V_{GS} = 0\text{ V}, I_{SD} = 6\text{ A}$		3.55		V

Dynamic Electrical Characteristics

Characteristics	Symbol	Conditions	Min	Typ	Max	Units
Input Capacitance	C_{ISS}	$V_{DS} = 400\text{ V}, V_{GS} = 0\text{ V}, f = 100\text{ kHz}$		53.5		pF
Reverse Transfer Capacitance	C_{RSS}	$V_{DS} = 400\text{ V}, V_{GS} = 0\text{ V}, f = 100\text{ kHz}$		0.8		pF
Output Capacitance	C_{OSS}	$V_{DS} = 400\text{ V}, V_{GS} = 0\text{ V}, f = 100\text{ kHz}$		13.3		pF
Total Gate Charge	Q_G	$V_{DS} = 400\text{ V}, V_{GS} = 0\text{ V to } 6\text{ V}$		1.9		nC
Gate to Source Charge	Q_{GS}	$V_{DS} = 400\text{ V}, V_{GS} = 0\text{ V to } 6\text{ V}$		0.27		nC
Gate to Drain Charge	Q_{GD}	$V_{DS} = 400\text{ V}, V_{GS} = 0\text{ V to } 6\text{ V}$		0.95		nC
Output Charge	Q_{OSS}	$V_{DS} = 400\text{ V}, V_{GS} = 0\text{ V}$		12.7		nC
Output Capacitance Stored Energy	E_{OSS}	$V_{DS} = 400\text{ V}, V_{GS} = 0\text{ V}$		1.6		μJ
Effective Output Capacitance (Energy related)	$C_{O(ER)}$	$V_{DS} = 0\text{ V to } 400\text{ V}, V_{GS} = 0\text{ V}$		20.0		pF
Effective Output Capacitance (Time related)	$C_{O(TR)}$	$V_{DS} = 0\text{ V to } 400\text{ V}, V_{GS} = 0\text{ V}$		31.8		pF

Static main characteristics ($T_J = 25^\circ\text{C}$ unless otherwise noted)

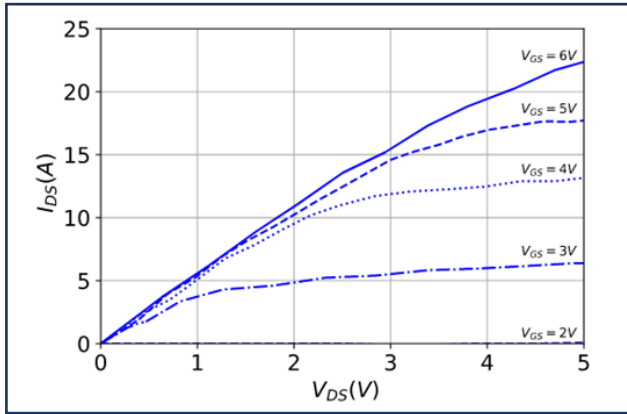

Figure 1. Output I_{DS} . V_{DS}

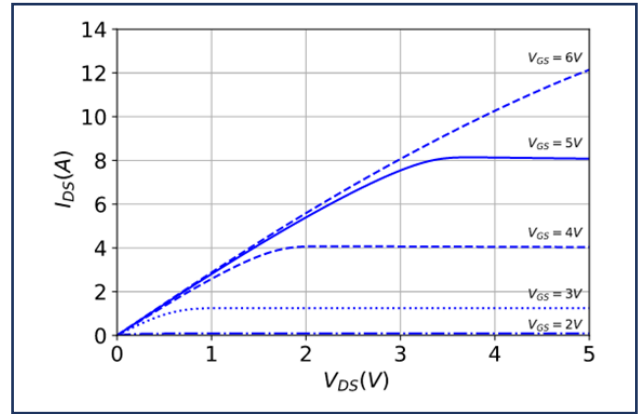

Figure 2. Simulated output I_{DS} . V_{DS}
 $T_J = 125^\circ\text{C}$

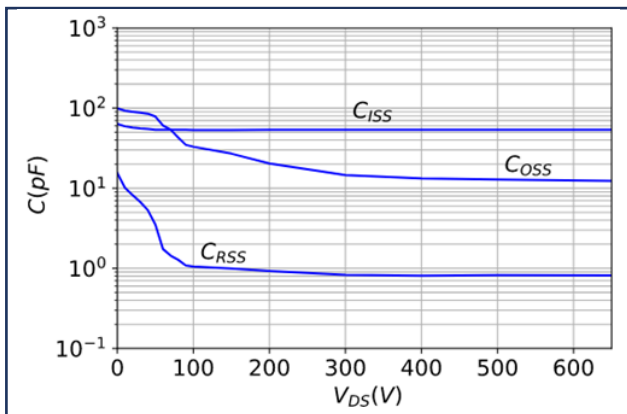

Figure 3. Capacitance

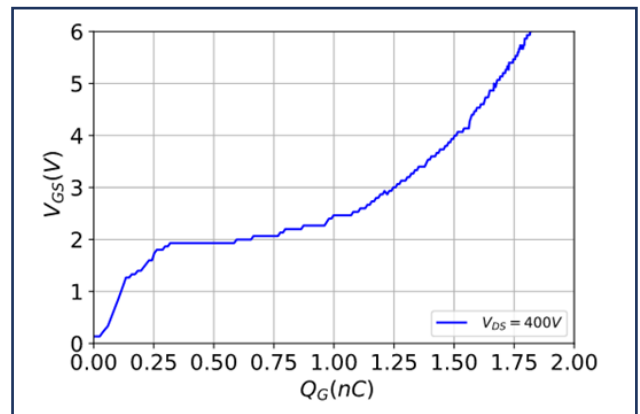

Figure 4. Gate Charge, Q_G

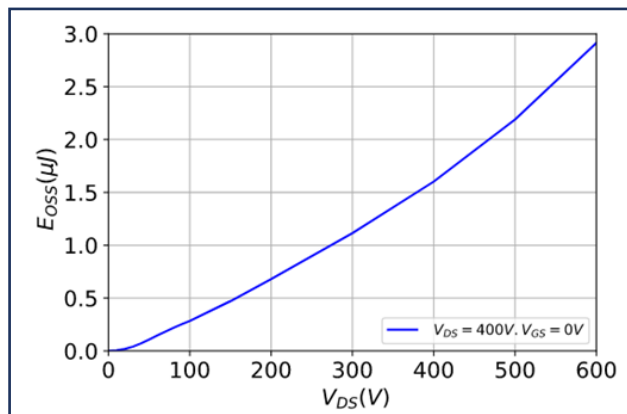

Figure 5. Stored Energy

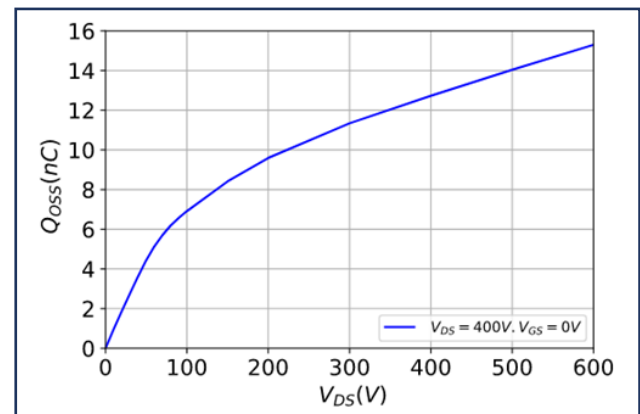

Figure 6. Output charge

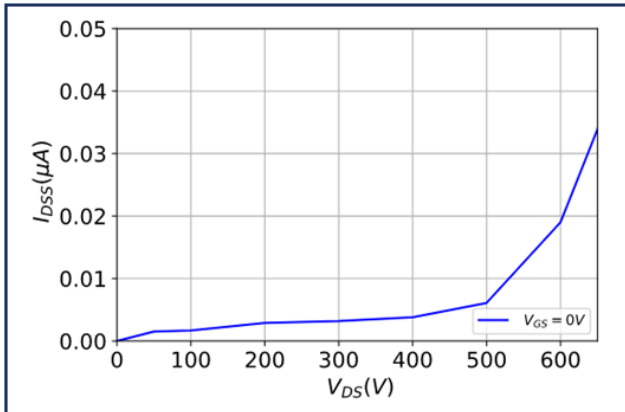

Figure 7. Drain-source leakage
T_J = 25°C

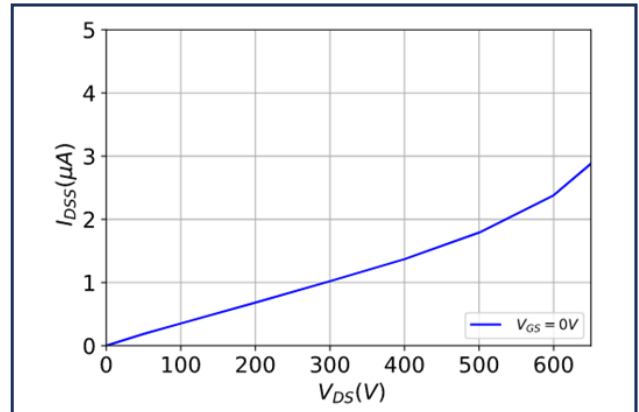

Figure 8. Drain-source leakage
T_J = 125°C

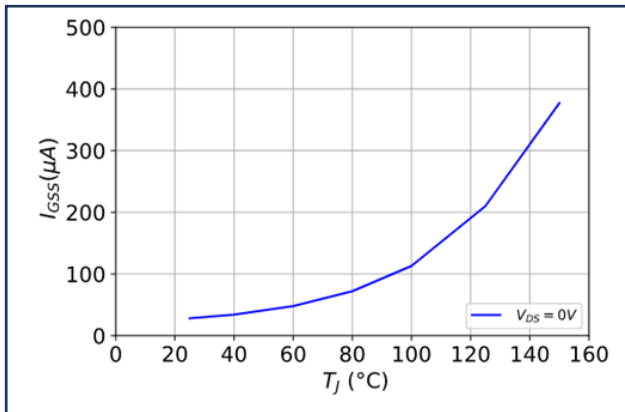

Figure 9. Gate-source leakage vs Temperature

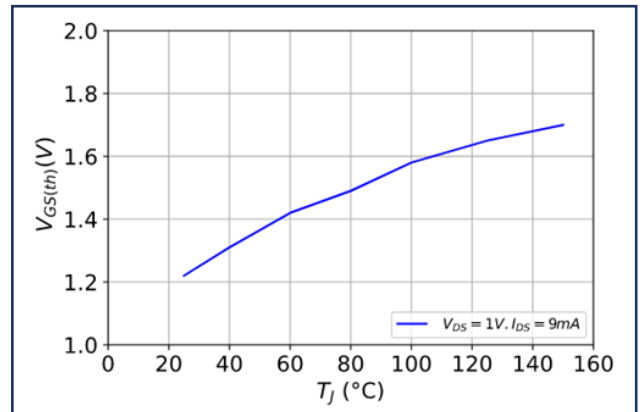

Figure 10. V_{GS(th)} vs. Temperature

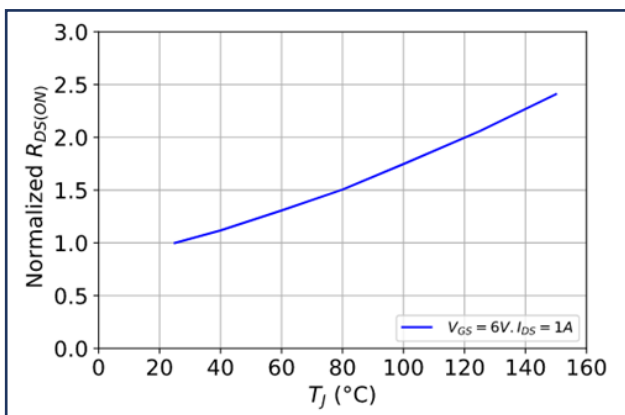

Figure 11. R_{DS(on)} vs. Temperature

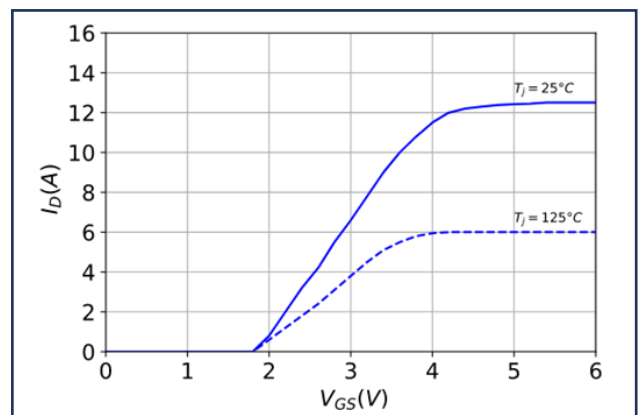

Figure 12. Transfer characteristics

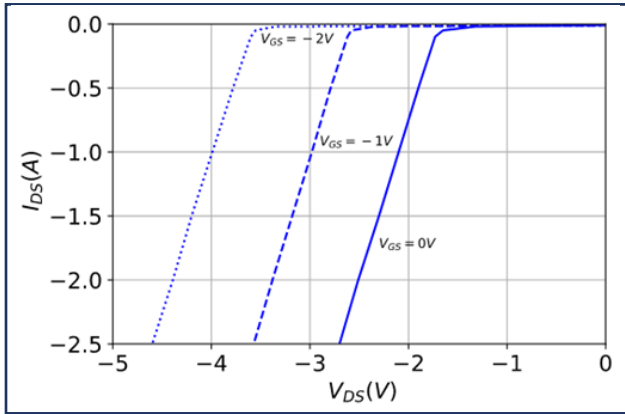

Figure 13. Reverse Conduction
 $T_J = 25^\circ\text{C}$

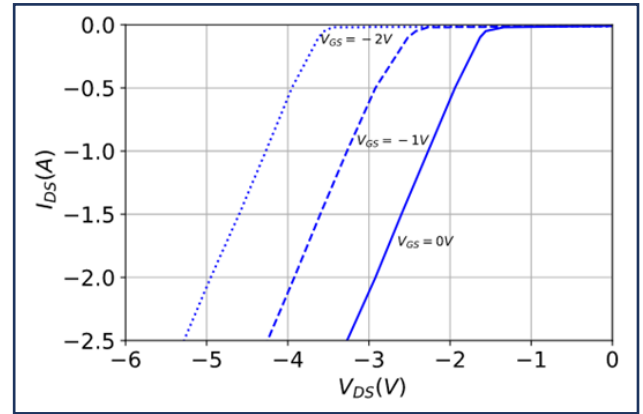
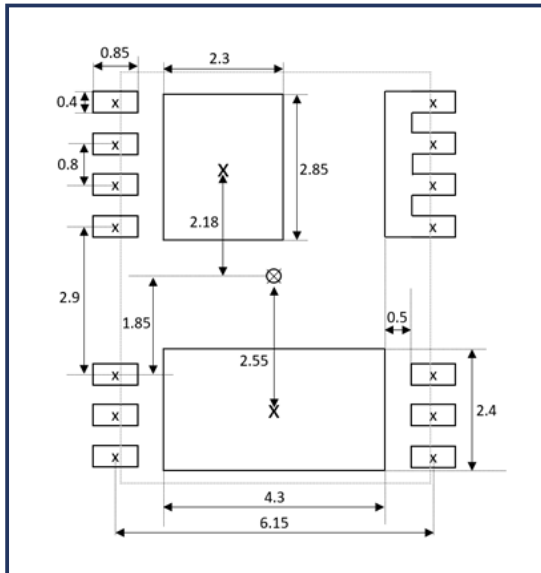

Figure 14. Reverse Conduction
 $T_J = 125^\circ\text{C}$

Package and Packing information

Land Pattern



Pinout

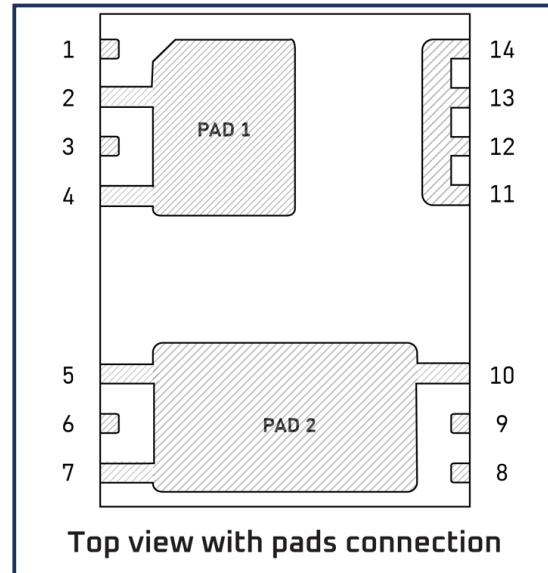

Number	Name	Function	Description
1	G1	Signal	Gate of high side GaN transistor
2	KS1	Signal	Kelvin source of high side GaN transistor
3		NC	Not connected pin
4		Supply	Connected to PAD 1
5		Supply	Connected to PAD 2
6	G2	Signal	Gate of low side GaN transistor
7	KS2	Signal	Kelvin source of low side GaN transistor
8		NC	Not connected pin
9		NC	Not connected pin
10		Supply	Connected to PAD 2
11	VIN	Power	Drain of high side GaN transistor
12	VIN	Power	Drain of high side GaN transistor
13	VIN	Power	Drain of high side GaN transistor
14	VIN	Power	Drain of high side GaN transistor
PAD1	OUT	Power	Source of high side and drain of low side GaN transistor
PAD2	GND	Power	Source of low side GaN transistor

Package Outline Drawing

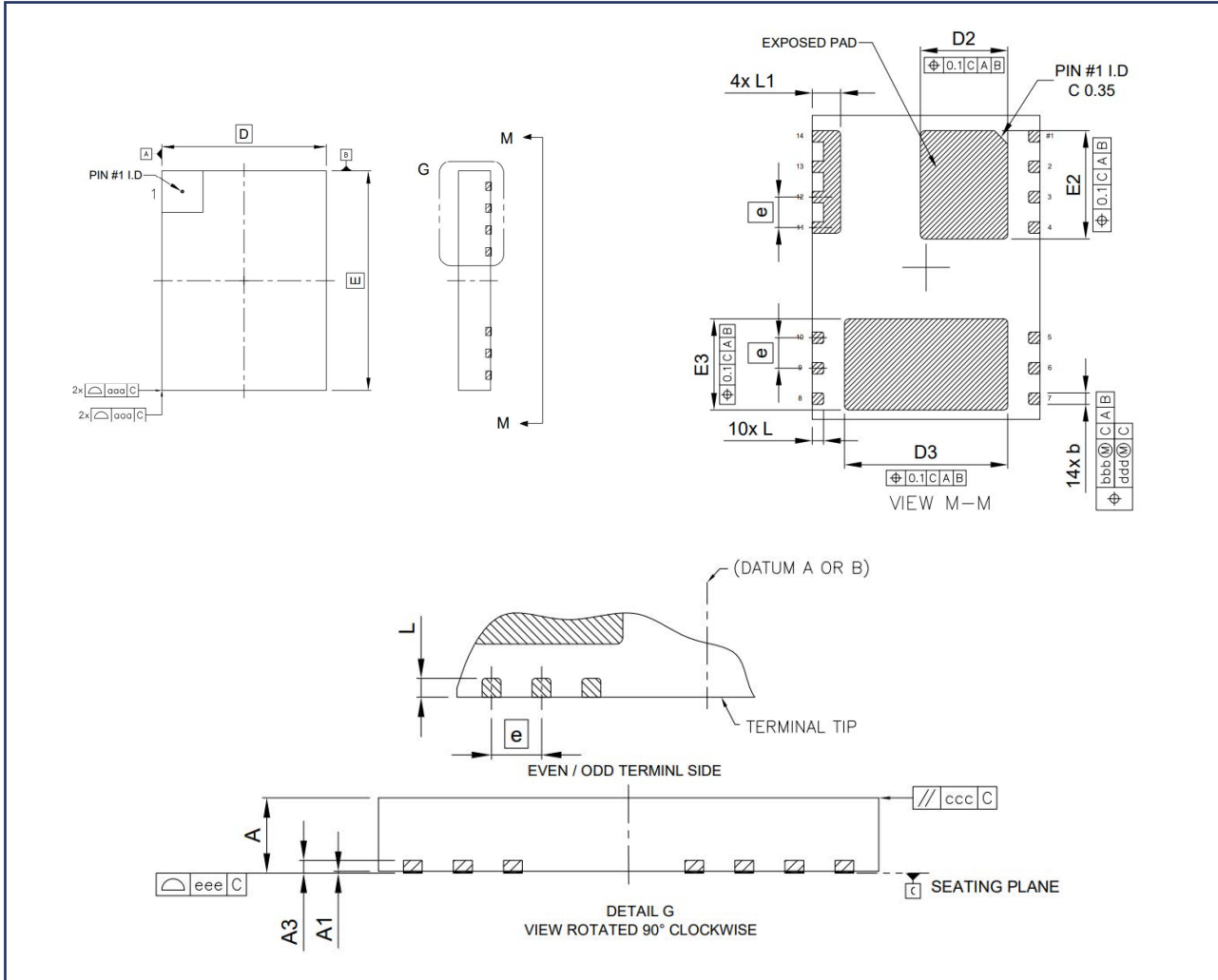

Dim	Min	Nom	Max	Unit
A	1.15	1.20	1.25	mm
A1	0.00		0.05	mm
A3	0.203 REF			mm
b	0.25	0.30	0.35	mm
D	6.00BSC			mm
E	8.00 BSC			mm
D2	2.20	2.30	2.40	mm
E2	2.75	2.85	2.95	mm
D3	4.20	4.30	4.40	mm

Dim	Min	Nom	Max	Unit
E3	2.30	2.40	2.50	mm
e	0.80 BSC			mm
L	0.25	0.30	0.35	mm
L1	0.70	0.75	0.80	mm
aaa	0.10			mm
bbb	0.10			mm
ccc	0.10			mm
ddd	0.05			mm
eee	0.08			mm

Tray dimensions (in mm)

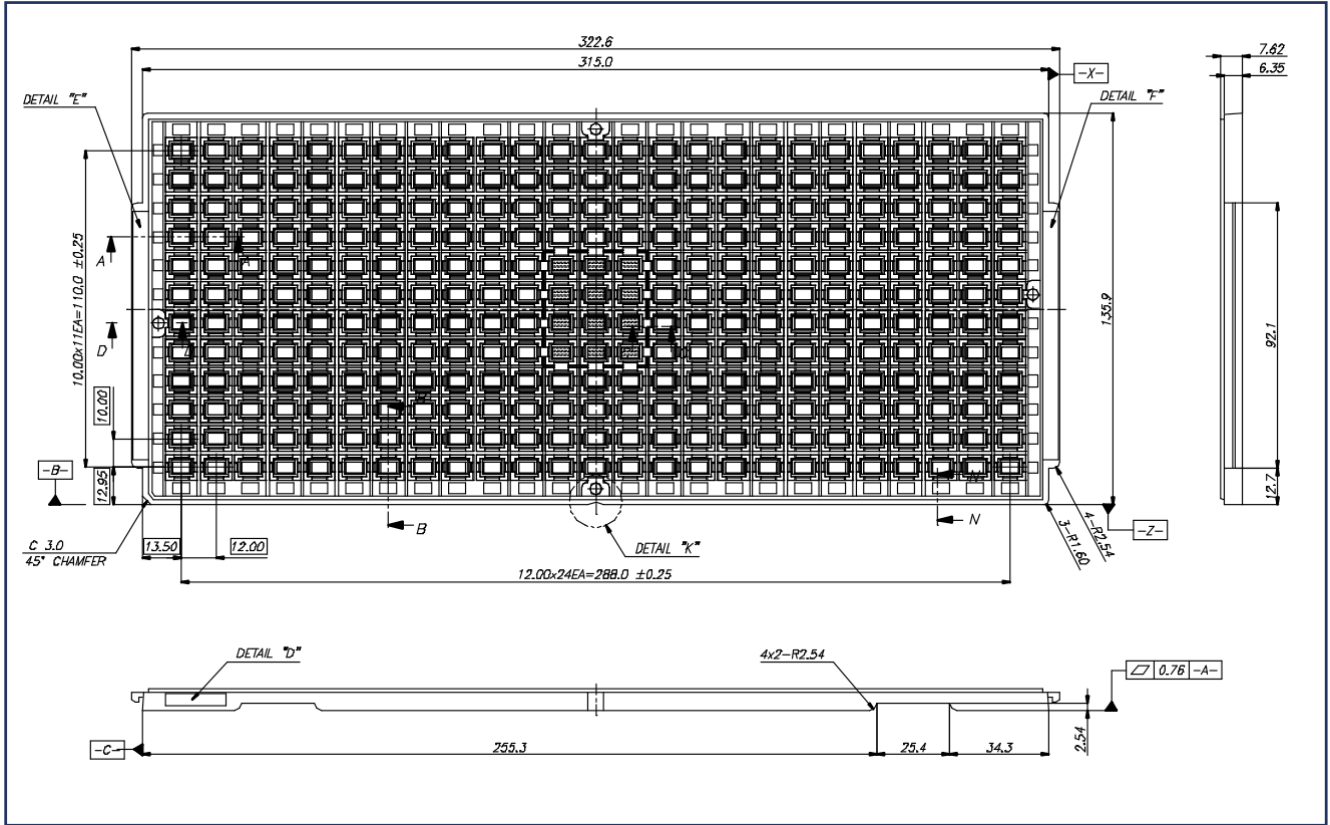

Tape and Reel Dimensions (in mm)

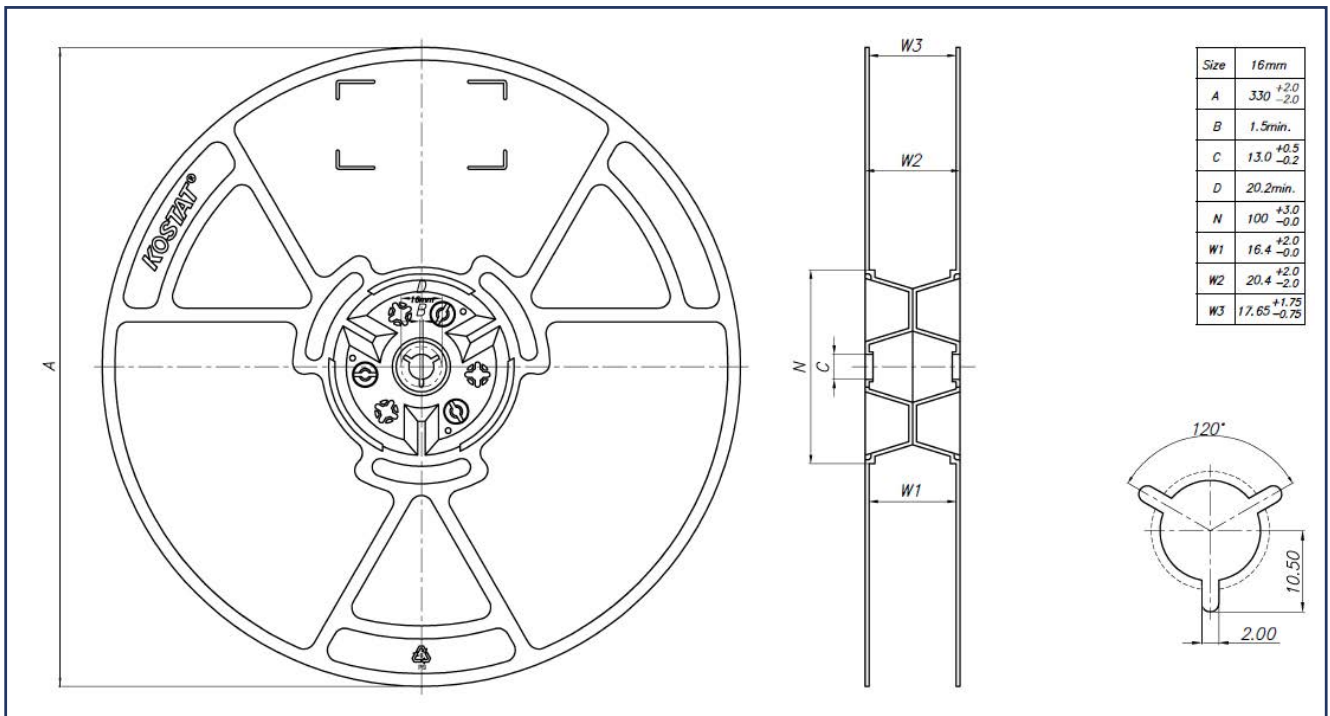

Ordering Information

Ordering code	Package type	Packing method	Qty	Tray Qty	Box tray
WI62195T	6 x 8 mm PDFN	Tray	1500	12 x 25 parts	5
WI62195TR	6 x 8 mm PDFN	Tape and Reel	5000	N/A	N/A

Propriety of Wise-Integration SAS. Any disclosure, distribution, copy of this document is strictly prohibited.



contact@wise-integration.com